

NSK Precision Products

Enabling the Future as Your Partner



GLOBAL BRAND

NSK products are known and used all over the world

Since 1916, when it was the first company in Japan to produce ball bearings, NSK has contributed to industrial growth both domestically and overseas for more than 90 years. Now, the company's accumulated technology in bearings has been applied to precision products in order to support core components used in a variety of machinery.

Precision products marketed under the trusted NSK brand, such as Ball Screws, Linear Guides, Monocarriers, mechatronic products, and Spindles are found in every corner of the globe.



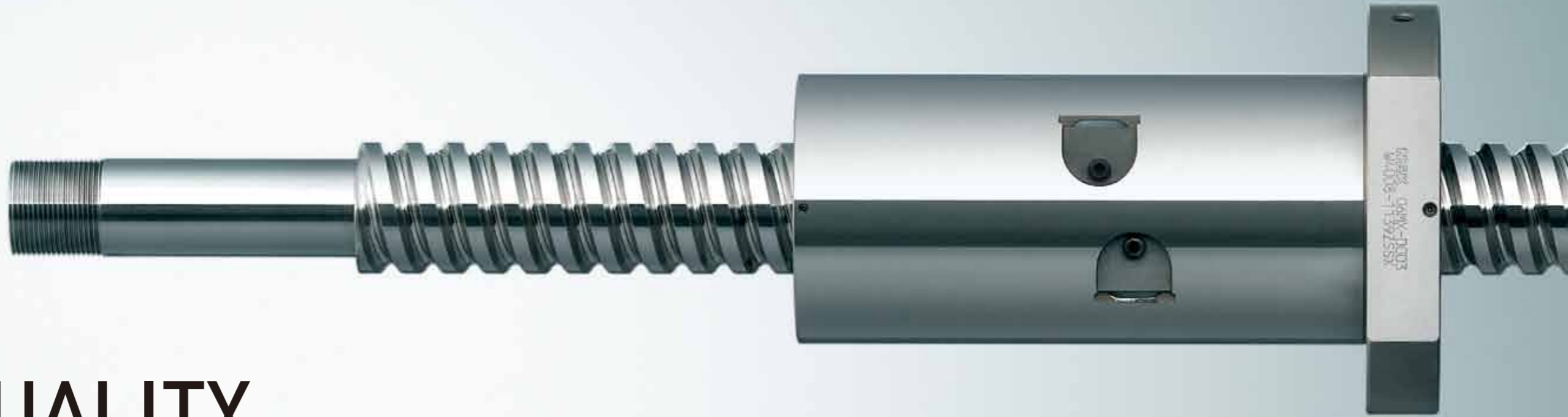

TOTAL QUALITY

Focus on customers' total quality

Product quality is essential for manufacturers. NSK builds on its solid foundation of quality to enhance its ability to offer solutions that add value for customers, taking advantage of capabilities afforded by supply chain management (APS: Advanced Production System), and further extending its technical expertise based on four core technologies. Quality is the objective in all our business processes toward becoming “No. 1 in Total Quality.”





SOLUTIONS

Improvement of customers' product value by technical support

Solutions only NSK can propose are contributing to the advancement of manufacturing for a new era.

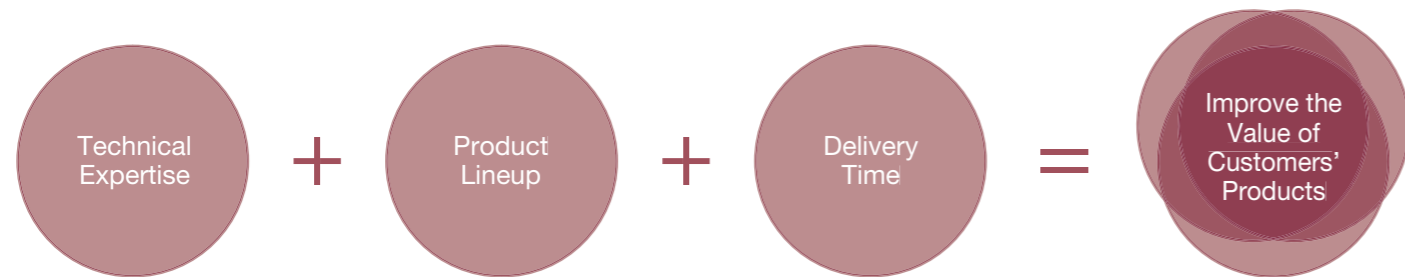

With its Technology Center as the cornerstone, NSK is able to provide technical support worldwide and quickly offer innovative solutions. We are able to more rapidly deliver the required products by combining a global production system with a broad lineup that includes precision products and bearings. These detailed solutions and technical support efforts enable us to enhance the value of our customers' products and thereby deepen our partnerships with those customers.

APS

Advanced production system for speed, quality and global supply chain management

NSK has streamlined operations to cut lead times and achieve faster delivery.

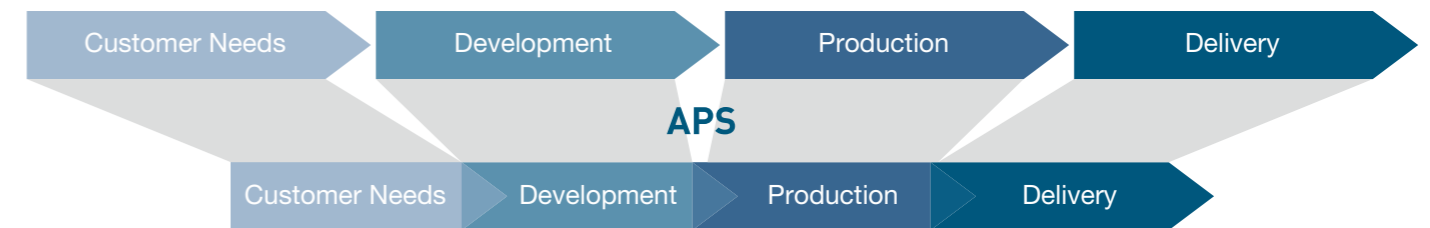

To more effectively respond to customer needs, NSK implemented APS (Advanced Production System) encompassing sales, development, design, manufacturing and distribution. Under our APS, we established a project for streamlining operations to shorten lead times. As a result, the system has boosted supply capacity and directly addressed customer demand.

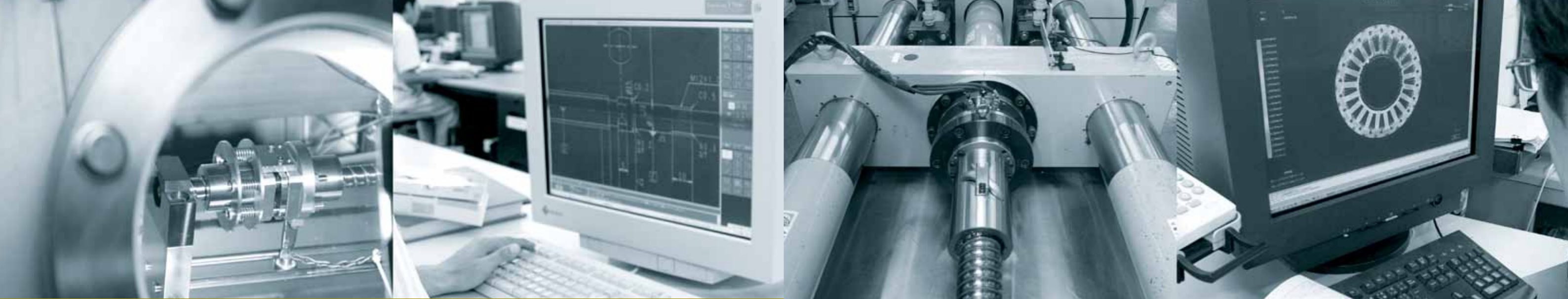

TECHNOLOGY

Developing innovative technologies and products by our four core technologies

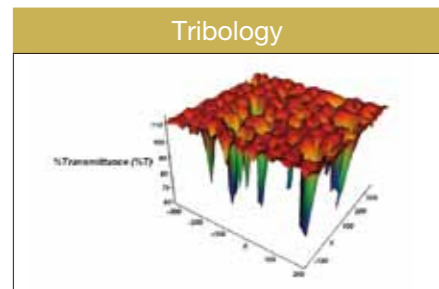

Precision products with rotational and linear movement require lubrication that supports high speed, low noise operation, load capacity, durability, and other desirable functionality. NSK has applied, and provided to customers, advanced tribology (friction control technology) to such areas as grease, solid lubricants, and surface processing methods for precision products.

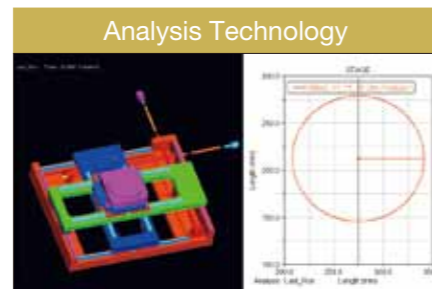

NSK utilizes computer simulations to conduct virtual experiments that require high precision or are difficult to run under actual machine operating conditions. Further improvements in analysis technology have accelerated product development.



We are aggressively striving to advance material technology through material design, thermal treatment, performance evaluation, and analysis as the cornerstone for improving product performance and durability as well as for reducing costs and boosting productivity.

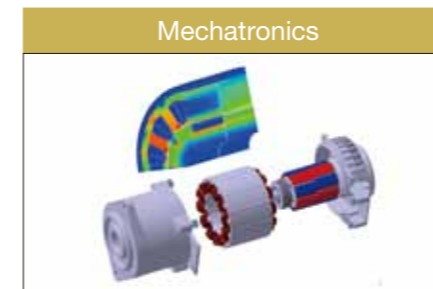

Our mechatronics, which integrate mechanical and electronic elements, incorporates state-of-the-art advances in high-performance motors along with control and sensor technology.

Environmental Initiatives

Approach and Basic Policy for Development and Design

In its Environmental Code of Conduct, the NSK Group aims to develop technology and create products that reduce environmental impact. NSK Group products are incorporated into various machines and devices and have the ability to control friction and reduce the amount of energy consumed. In the product development and design stage, importance is placed on comfort, preservation of natural resources, and energy conservation at the end-user stage, as well as on reducing the environmental impact of the manufacturing process. Therefore, initiatives are being promoted to utilize the environmental features of NSK products. In fiscal 2001, a basic policy affecting all technical departments was established in order to steadily implement these goals.

Basic Policy for the Development of Environmentally Friendly Products

The NSK Group will minimize the environmental impact of its products at every stage—from R&D and design, to production, usage, and disposal—by upholding the following standards:

1. Each product should contribute toward the energy and resource conservation by the machine in which it is installed.
2. The amount of energy and resources required during product manufacturing should be minimal.
3. Environmentally harmful substances should not be used in products or manufacturing processes.
4. Products should contribute to the health and safety of end-users by having low emissions of vibration, noise, and dust.

Green Procurement Policy

The NSK Group actively procures products, parts, and materials based on environmental considerations. By managing environmentally harmful substances with its suppliers, NSK is strengthening its environmental quality assurance system for its products.

Green Procurement Standards

The NSK Group must deliver products that ensure satisfaction and meet the European and each country's regulations. Therefore, NSK has established standards for procurement such as the Master Purchase Agreement and the *Green Procurement Standards*, based on the idea that ecological considerations for parts and material procurement are indispensable to environmental protection. The company has asked its suppliers to cooperate in this effort.



Conference for Green Procurement

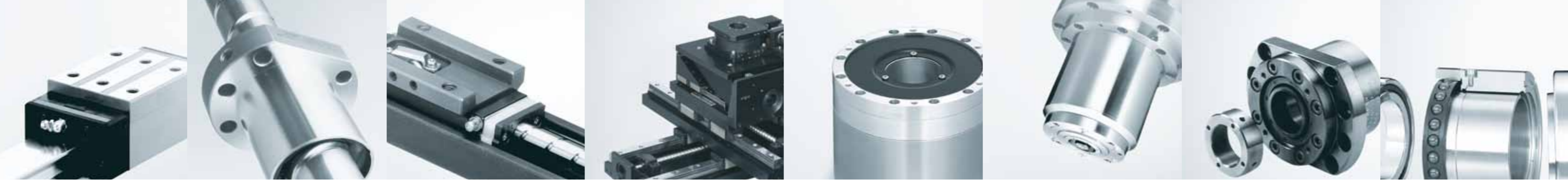

HISTORY

REVIEW

Global activities of NSK's precision machinery and parts business

<p>Kita Nippon Seiko established, fully funded by NSK. Construction of Maebashi Plant began.</p> <p>Kita Nippon Seiko started manufacturing ball screws.</p> <p>Kita Nippon Seiko merged with NSK and continued operations as the Maebashi Plant.</p> <p>Electronic Research Center established; company entered the device product field.</p> <p>Operation of Ball Screw design and production system started.</p> <p>Total number of Ball Screws produced reached 1 million.</p> <p>Production of NSK Linear Guides transferred to the Saitama Plant.</p> <p>Precision Machinery and Parts Technology Center in Maebashi established.</p> <p>Franklin Plant, USA, started manufacturing ball screws. ISO 9002 quality management certification acquired.</p> <p>Newark Plant, UK, started manufacturing linear guides. ISO 14001 environmental management certification acquired.</p> <p>Production of mechatronic products transferred to Kirihara Plant. NSK Kyushu Co., Ltd. started manufacturing Ball Screws. ISO 9001 quality management certification acquired. NSK Precision Co., Ltd. established.</p> <p>Total number of precision Ball Screws produced at NSK Kyushu reached 1 million.</p> <p>Shenyang Plant in China started manufacturing Ball Screws. Changwon Plant in Korea started manufacturing Linear Guides.</p> <p>Linear Technology Center in Fujisawa established. NSK Precision Co., Ltd joins NSK Ltd.</p>	<p>1960 Precision Ball Screw developed.</p> <p>1961</p> <p>1967</p> <p>1980 Precision Positioning Table developed. Expanded into mechatronics field. Air Spindles for wafer dicing developed. NSK Linear Guides developed.</p> <p>1982</p> <p>1983</p> <p>1984 Miniature NSK Linear Guides developed. Megatorque Motors developed. Cartridge Spindles developed.</p> <p>1985 Semiconductor exposure equipment developed and Robot Module developed.</p> <p>1986 Linear Guides random-matching type developed. Air hydrostatic bearing made of ceramics developed. Ceramic Ball Screw developed. "Robotte" Ball Screw with spline developed.</p> <p>1987</p> <p>1988 Linear Guides LH Series developed.</p> <p>1989 RZ LCD color filter exposure equipment developed.</p> <p>1990 Monocarrier developed.</p> <p>1991 Linear Guides LS Series developed.</p> <p>1993 New Robot Modules developed.</p> <p>1995 Linear Guides equipped with NSK K1 lubrication unit developed. NDD Series Ball Screws with vibration damper developed.</p> <p>1996 HTF Series Ball Screws for heavy loads developed.</p> <p>1997 Ball Screws equipped with NSK K1 lubrication unit developed. New Megatorque Motor developed.</p> <p>1998</p> <p>1999 Linear Guides S1 Series developed.</p> <p>2000</p> <p>2001 Translide developed. Ball Screws and Linear Guides with DFO lubricant coating developed.</p> <p>2002 Linear Guides High-Accuracy Series developed. Linear Guides PU Series developed.</p> <p>2003 BSS Series high-speed, low-noise Ball Screws developed. Roller Guides developed. High-speed integrated motor spindles developed. Linear Guides PE Series developed.</p> <p>2005 HTF-SRC Series Ball Screws for high speed and heavy loads developed. Linear Guides V1 Series developed.</p> <p>2006 HMD Series Ball Screws for high-speed machine tools developed.</p> <p>2007 A1 Series grease-retaining Ball Screws developed.</p> <p>2009 Toughcarrier developed. High-speed and low-noise miniature high-helix lead ball screws developed.</p> <p>2010 Ball screws equipped with X1 Seal for machine tools developed. Ball screws for high-speed machine tools HMS Series developed. Ball screws for high-speed and high-load drive HTF-SRE Series developed. Nut cooling ball screws developed.</p> <p>2012</p>
--	---

[Exhibitions]

■ Japan International Machine Tool Fair [JIMTOF]

JIMTOF is one of the world's most renowned biennial machine tool fairs. Held in Japan, JIMTOF brings together the most advanced machine tools and relevant products. As the only comprehensive R&D firm and manufacturer of elemental machine tool parts, NSK is working to contribute to the development of a range of industries, and is utilizing its combined strengths to stay abreast of changing market conditions. Under the theme of "Your Real Partner", in recent fairs, NSK has been promoting highly-functional machines with increased dependability as a means of solving customers' problems as a reliable partner.



■ Exposition Mondiale de la Machine Outil [EMO]

EMO is a world-leading fair showcasing metal processing technologies, including machine tools. It is held in Hanover, Germany and Milan, Italy every other year. In the latest EMO, NSK presented the company's comprehensive strengths and dependability under the theme of "Partnership based on trust - and trust based on quality".



■ International Manufacturing Technology Show [IMTS]

IMTS is a world-leading trade show that showcases manufacturing technologies such as machine tools. It is held in Chicago, U.S., every other year, and as a machine tools exhibition, it is comparable with JIMTOF and EMO.

In recent shows, NSK has presented its technological capabilities, dependability, and comprehensive strengths to the world, based on the themes set by JIMTOF.



■ China International Manufacturing Technology Show [CIMT]

CIMT is the largest international machine tool trade show held in China. It has been held every other year in Beijing since 1989. CIMT has grown in size every time, and it is now one of the four largest machine tool fairs in the world along with JIMTOF, EMO and IMTS. NSK participated in the trade show with linear rolling products including ball screws and linear guides, precision bearings for machine tools, and spindles. The latest NSK technologies and products that have been built to respond to the diverse demands of the expanding Chinese market are displayed and receive favorable comments every time.

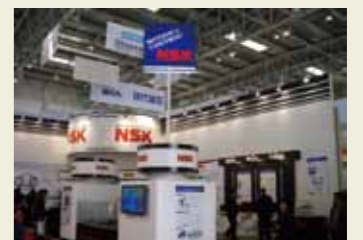

■ SEMICON WEST

SEMICON WEST is one of the world's largest exhibitions of semiconductor manufacturing equipment and materials. It is held every year in San Francisco, near San Jose, California, where Silicon Valley is located. Approximately 700 companies participate in the exhibition and nearly 30,000 visitors from around the world attend. NSK has been participating in this event every year to exhibit its latest technology and demonstrate the company's dependability. NSK products have been contributing to the development of high-tech industries by acting as key components in semiconductor manufacturing equipment.



NSK Global Network

NSK provides the best products all over the world by our global network.

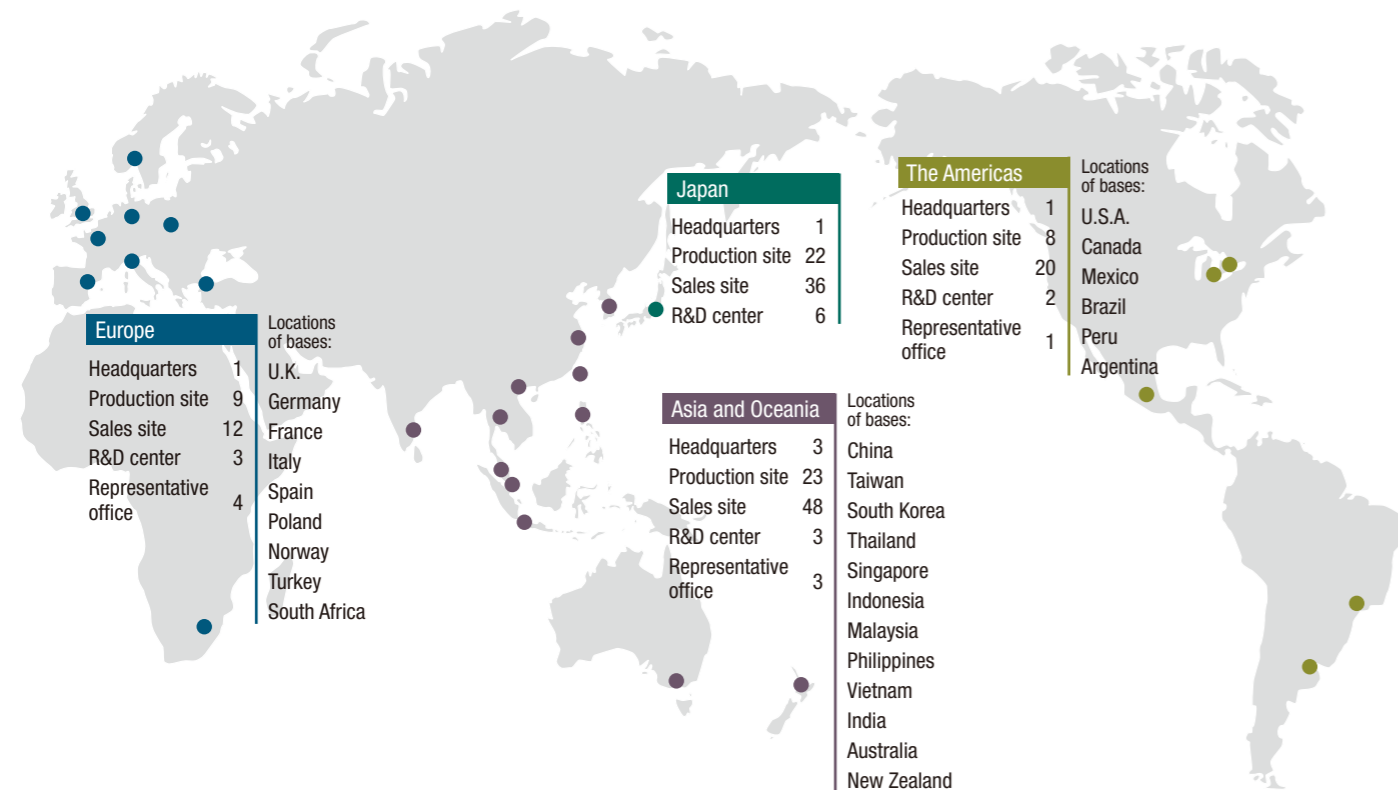

NSK Ltd. Headquarters (Shinagawa, Tokyo)

Research & Development

NSK's research system takes full advantage of knowledge on technology shared through its information network.



Linear Technology Center

Kiri-hara, Fujisawa, Kanagawa

The Linear Technology Center plays a vital role in developing next-generation precision products in cooperation with NSK Technology Development Center. For new products or those used for special purposes, reliability testing is essential. Each technology division has introduced instruments developed by NSK to evaluate the various aspects of product performance. Experiments conducted by the Center are designed according to specific application conditions, such as operating life and durability. The Center also undertakes vacuum environment testing for semiconductor and LCD manufacturing equipment as well as sound and vibration testing. In addition, accumulated test data is stored in a database, which has proved to be a valuable resource. The Center is constantly striving to develop new industry-leading products.



NSK Technology Development Center

Fujisawa, Kanagawa

The NSK Technology Development Center supports the future of NSK by conducting research and development into innovative technologies, such as tribology, analysis technology, materials technology, and mechatronics. This Center develops high added-value, next-generation products by broadly disseminating data and exchanging information with the Linear Technology Center and R&D centers in the Americas, Europe and Asia.

Manufacturing Bases



Global manufacturing bases assist in maintaining the high-quality “NSK brand.”

Ball Screws Manufacturing Sites



NSK Kyushu Co., Ltd.

Ukiha, Fukuoka

As the world's No. 1 production base for Ball Screws, NSK Kyushu Co., Ltd. is striving to realize unsurpassed QCD (quality, cost, delivery) and earn customer trust. NSK Kyushu Co., Ltd. endeavors to shorten delivery time with NSK's proprietary production management system.

Products: Ball Screws



Maebashi Precision Machinery Plant

Maebashi, Gunma

As a production base for precision machinery components, the Maebashi Precision Machinery Plant manufactures world-class products, including large Ball Screws and Monocarriers, by fully applying state-of-the-art techniques based on the highest level super-precision technologies. NSK's own production methods ensure meticulous quality control throughout the entire production process.

Products: Ball Screws, Monocarriers, Support Units



Shenyang NSK Precision Co., Ltd.

Shenyang Plant

Shenyang, China

Shenyang NSK Precision Co., Ltd. was established in 2009 as a precision ball screw production base to meet the market needs of the emerging countries such as China, where demand is expected to grow. By adopting NSK's own production technology developed in a Japanese plant and performing meticulous quality control, Shenyang NSK Precision Co., Ltd. endeavors to shorten delivery time.

Products: Ball Screws



NSK Precision America, Inc.

Franklin Plant

Indiana, U.S.A.

Established in 1993, this plant serves as a production base for Ball Screws. It actively supplies Linear Guides and mechatronic products to meet a wide range of market needs in such areas as machine tools, semiconductors, medical equipment and general industrial applications. The plant also promotes various projects and advanced production system (APS) activities in concert with other plants in Japan to achieve further advances toward even faster delivery systems to meet the demands of a broader market.

Products: Ball Screws, Monocarrier, XY Tables

Linear Guides Manufacturing Sites



Saitama Precision Machinery Plant

Hanyu, Saitama

The Saitama Precision Machinery Plant manufactures Linear Guides that are widely used in machine tools, transportation systems, and other applications. With its ground-breaking processing technology and thorough factory automation, the plant contributes to enhancing customer satisfaction by producing high-quality products.

Products: Linear Guides



NSK Precision UK, Ltd.

Newark Plant

Nottinghamshire, U.K.

The Newark Plant was established in 1998 as a Linear Guide production base that supports short-term delivery along with a European warehouse, a sales base in Europe, and a workshop. The plant is part of a system that covers not only major markets in Europe but also general industrial markets in Eastern Europe and the Middle East. It also pursues streamlining in accordance with globalization and plays an active role as a global sourcing facility by supplying products to the Americas.

Products: Linear Guides



NSK Korea Co., Ltd.

Changwon Plant

Changwon, Korea

The Changwon Plant was established in 2010 as a production base for the supply of linear guides to the growing Korean market and its key industries: automotive, IT and machining tools. The plant is answering to the needs of the Korean market and plays an important role in NSK's global sourcing strategy.

Products: Linear Guides

Mechatronics and System Products Manufacturing Site



Mechatronics Business Department NSK Technology Co., Ltd.

Kirihara, Fujisawa, Kanagawa

This department and NSK Technology Co., Ltd. produce mechatronic products and system components, including Megatorque Motors and air bearings. By adopting the most advanced grinders and proprietary evaluation systems, the division conducts meticulous quality control in its quest to manufacture products with ever-higher precision and functionality.

Products: Megatorque Motors, XY Tables, system components, air bearings

Ball Screws

With the world's leading Ball Screw, NSK has been contributing to industrial growth

NSK Ball Screws were developed through cutting-edge tribology (friction control technology), and NSK manufactures the largest volume in the world with its outstanding production and quality control techniques.

We offer a complete selection of Ball Screws, from miniature to ultra-large sizes, for machine tools, injection molding machines, and general machinery as well as for use under special environments, such as semiconductor and LCD production equipment.



Lubrication Units

NSK K1™



NSK K1™ lubrication unit ensures long-term, maintenance-free operation and the long operating life of components under tough lubrication environments; clean lubrication method exerts less impact on the environment.

Features:

1. Long-term, maintenance-free operation
2. Long operating life
3. NSK K1™ for food processing or medical equipment also available

CAT. No. E3331

Highly Dust-Resistant Ball Screws

V1 Series



NSK's most advanced high-performance seals deliver more than four times longer service life under contaminated environments than conventional models.

Features:

1. High dust-resistance (specially profiled ball groove of the screw shaft)
2. Long operating life

CAT. No. E3162

High-Speed, Low-Noise Ball Screws

BSS Series



Quiet and compact, with unparalleled high-speed performance. Low-noise BSS Series Ball Screws are suitable for an extensive range of uses, from transportation equipment to machine tools.

Features:

1. Low noise
2. High speed
3. Compact design

CAT. No. E3229, E3162

Ball Screws for Twin-Drive Systems

TW Series



TW Series Ball Screws deliver the ideal functionality for twin-drive systems and easily realize the high rigidity, accuracy and responsiveness of twin-drive tables.

Features:

1. High rigidity and long operating life
2. High accuracy
3. Excellent responsiveness

CAT. No. E3162

High-Speed, High-Load Ball Screws

**HTF Series/HTF-SRC Series/
HTF-SRD Series/HTF-SRE Series**



Easy-to-use ball screws for high-load applications. Wide variety of products suited for high-load drives.

Features:

1. High-load capacity
2. Low noise
3. High-speed

CAT. No. E3238, JSP-101024

NSK Standard Ball Screws

Compact FA Series



Standard series for immediate delivery of BSS Series high-speed, low-noise Ball Screws; next-generation compact Ball Screws offer quiet, high-speed operating performance.

Features:

1. Compact design
2. Low noise
3. High speed

CAT. No. E3239

Ball Screws for High-Speed Machine Tools

**HMD Series
HMS Series**



Upgraded version of the highly regarded HMC Series, featuring new recirculation method that enables high-speed, low-noise operation. Nut cooling ball screw is also available.

Features:

1. High-load capacity
2. Low noise
3. High speed

CAT. No. E3162, ESP-101025,
ESP-101027

Ball Screws Equipped with X1 Seal



Less maintenance is required due to highly-contact seal for machine tools, which achieved greater dust resistance and sealing performance.

Features:

1. Dust resistance
2. Sealing capability
3. Low torque

Grease Retaining A1 Seal

HTF-ASRC Type/ HTF-ASRD Type



The grease retaining characteristics of ball screws have greatly improved owing to the A1 seal. The A1 seal helps to maintain a clean and healthy environment.

Features:

1. Grease retaining performance
2. Clean environment maintenance
3. Low friction torque and low heat generation

CAT. No. E3238

Thin-Film Lubrication for Vacuum Environments

**Ball Screws with E-DFO
for Vacuum Environments**



Further advanced DFO thin-film lubrication technology ensures significantly longer life and lower outgassing in vacuum environments.

Features:

1. Suitable for high vacuum environments
2. Low outgassing
3. Low friction

CAT. No. E1258

NSK Linear Guides

A wide range of products, from machine tools to medical equipment, that satisfy the needs of customers

The manufacturing process for NSK Linear Guides incorporates production technologies that ensure high precision and outstanding quality. We offer an extensive product lineup, high-load capability, and excellent dust-resistant performance to meet the needs of a variety of industries, from semiconductor manufacturing equipment to general industrial devices. We are able to quickly and reliably meet expanding customer needs by offering various products such as miniature Linear Guides for special specifications.

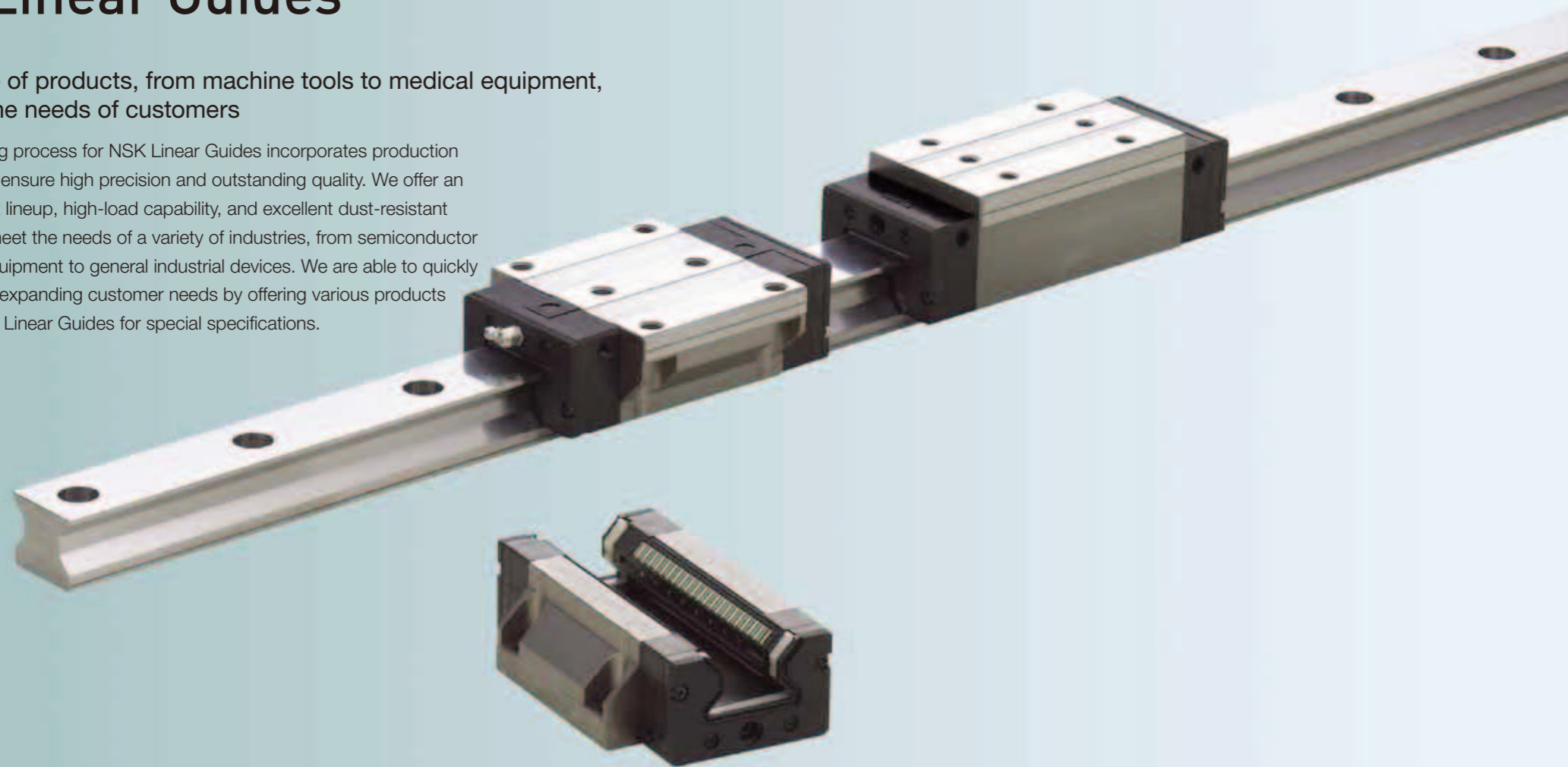

NSK Linear Guides Random-matching



NSK linear guides have wide variety of random-matching series. Lineup of random-matching rails and ball slides support and facilitates fast delivery.

- Features:
1. Interchangeable rails and ball slides
 2. Fast delivery
 3. Wide range of accessories

CAT. No. E3162, ESP-100427

NSK High-Accuracy Linear Guides **High-Accuracy Series**



High-performance Linear Guides with outstanding motion accuracy are designed for super high-accuracy machine tools or measuring equipment.

- Features:
1. High motion accuracy
 2. High rigidity
 3. Extra long bearing

CAT. No. E3329

NSK Roller Guides

RA Series



The most advanced Roller Guides, representing the culmination of NSK's analysis technology and tribology. With a complete lineup featuring high-load capacity and high rigidity, the RA Series meets the needs of a wide range of applications.

- Features:
1. High rigidity
 2. High accuracy
 3. Long operating life
 4. High dust resistance

CAT. No. E3328

NSK Standard Linear Guides

LH Series / LS Series



NSK's standard Linear Guide series satisfies the requirements of every industry with its versatile performance and conforms to international standard dimensions.

- Features:
1. Self-aligning capability
 2. Impact-load resistance
 3. Wide variety

CAT. No. E3162

NSK Linear Guides—Miniature

PU Series / PE Series



Light weight, compact and easy to use, NSK miniature Linear Guides ensure smooth operation.

- Features:
1. Smooth motion
 2. Light weight
 3. Incorporates stainless steel
 4. Low dust emission

CAT. No. E3327

Lubrication Units

NSK K1™



NSK K1™ lubrication unit ensures long-term, maintenance-free operation as well as the long operating life of components under tough lubrication environments; clean lubrication method exerts less impact on the environment.

- Features:
1. Long-term, maintenance-free operation
 2. Long operating life
 3. NSK K1™ for food processing or medical equipment also available

CAT. No. E3331

Roller Guides Equipped with V1 Seal



Newly developed, highly dustproof seals help extend the service life under environments with foreign matter. Ideal for environments where dust is generated.

- Features:
1. High-dust resistance
 2. Long operating life
 3. High resistance with NSK K1

CAT. No. ESP-101023

Highly Dust-Resistant NSK Linear Guides

V1 Series



NSK's most advanced high-performance seals deliver more than four times longer operating life under contaminated environments than conventional models.

- Features:
1. High dust-resistance (multi-lip structure seal)
 2. Long operating life

CAT. No. E3162

NSK Low-Noise Linear Guides

NSK S1™ Series



NSK S1™ Series ensures quiet, non-obtrusive sound and low dust emission while exhibiting smooth operation.

- Features:
1. Quiet, non-obtrusive sound emission
 2. Smooth motion
 3. Low dust emission
 4. Wide variety

CAT. No. E3162

Thin-Film Lubrication for Vacuum Environments

NSK Linear Guides with E-DFO for Vacuum Environments



Further evolved DFO thin-film lubrication technology ensures significantly longer operating life and lower outgassing in vacuum environments.

- Features:
1. Suitable for high vacuum environments
 2. Low outgassing
 3. Low friction

CAT. No. E1258

Monocarriers

All-in-one linear products that NSK originally developed ahead of any other manufacturer

A light-weight, single-axis actuator that embodies the technology NSK has accumulated over the years, with an all-in-one structure integrating a Ball Screw, Linear Guide, and support bearing.

NSK Monocarriers offer long-life, maintenance-free operation and are suitable for a wide range of applications. Monocarriers for clean environments are also available.



XY Tables

Suitable for semiconductor and LCD production equipment and medical analysis devices, XY Tables realize advanced positioning accuracy

With its positioning technology and proprietary evaluation technology, NSK provides high-quality XY Tables that contribute to the further development of the state-of-the-art electronics industry.

Based on our thorough research into performance requirements for semiconductor and LCD production equipment, we are able to offer the ideal XY Tables, exclusively designed using analysis technology.

We have also developed XY Tables for special conditions, such as vacuum and non-magnetic environments.

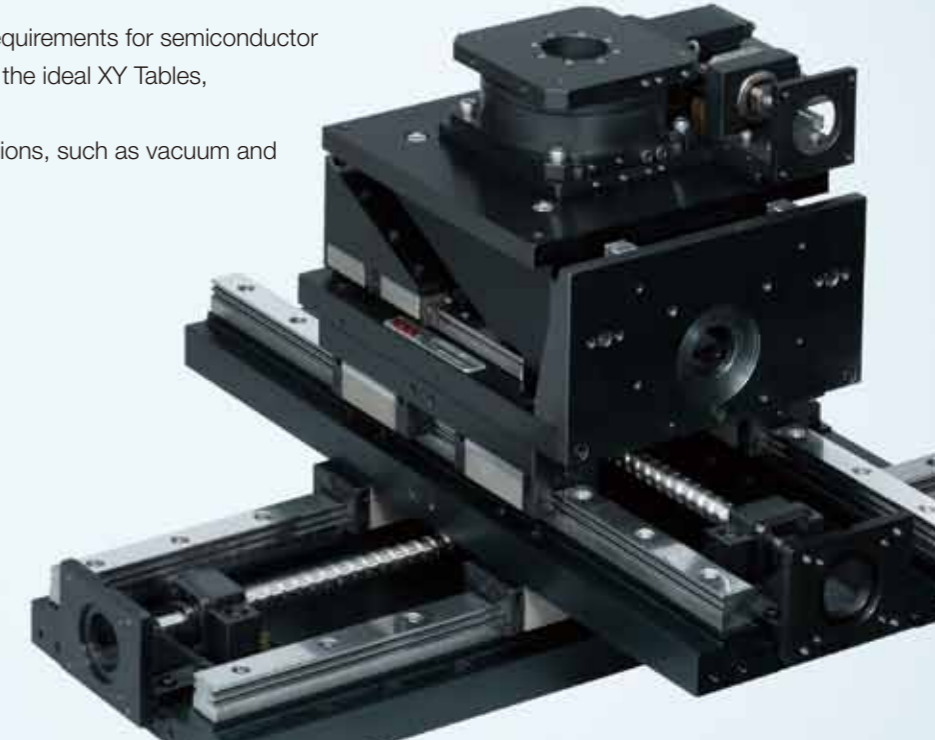

Monocarriers™

MCM Series/ MCH Series



Light-weight, compact, and high accuracy MCM Series is suitable for small-sized transfer equipment. MCH Series features a rail with high rigidity allowing it to be used as a beam member.

Features:

1. NSK K1 is equipped as a standard feature
2. Rust preventive capability
3. Abundant accessories

CAT. No. E3419, E3162

Monocarrier™

Ultra-High-Helix Lead Low-Noise MCM Series



2 500 mm/s of super-high speed feed. Ideal for semiconductor and liquid crystal manufacturing equipment.

Features:

1. High-speed feed
2. Low noise
3. Low dust emission

CAT. No. E3419, E3162

Precision Positioning Tables



Different combinations of NSK products and unique components to offer the ideal XY Table for each specific application.

Features:

1. Wide variety
2. High motion accuracy
3. Precision positioning table for air slides available

CAT. No. 3418

XY Modules



A single-axis module combining NSK Linear Guides and Ball Screws for greater freedom in control system design.

Features:

1. Flexible options for the choice of motor
2. Specification for clean environments available (optional)
3. Multi-axis combination available

CAT. No. 3417

Toughcarriers™



Single-axis actuator with super high-load capacity by installing rollers as the rolling elements. Toughcarrier and Monocarrier MCH Series are interchangeable.

Features:

1. High-load capacity
2. High-rigidity
3. Interchangeability with MCH Series

CAT. No. ESP-091002, ESP-101026, ESP-120127

Positioning Actuator



Positioning Actuator, combination of a high-accuracy and high-rigidity Monocarrier and a servo motor equipped with controller, realizes compact devices.

Features:

1. Easy operation thanks to the exclusive software "PA term"
2. Supports easy installation of machinery
3. Optimal products range

CAT. No. 3420

Megatorque Motors

Our Megatorque Motors demonstrate outstanding performance in highly accurate positioning and transportation equipment

With their high accuracy, high torque, light weight, and compact size, NSK direct drive motors improve productivity and contribute to higher accuracy, lighter weight, and greater compactness of various devices, such as high-speed robot arms.



Spindles

The world's premier product lineup boasts superior performance, including unprecedented machining ability and maintenance advantages

NSK Spindles take advantage of the company's world-class bearing technology. In particular, our integrated motor Spindle for machining centers features heavy machining capability and is the first high-speed rotation Spindle to adopt grease replenishment lubrication. With NSK Spindles, production lead times are reduced considerably.



Megatorque Motors™

PS Series

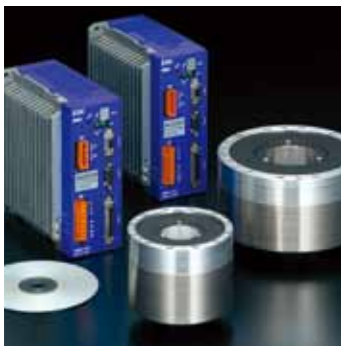

Advanced Megatorque Motors with high-speed, high-resolution capabilities.

Features:

1. High-speed positioning
2. Compact
3. High-accuracy position sensor
4. Outer rotor

CAT. No. E3511

Megatorque Motors™

PN Series



Newly developed, low profile Megatorque Motors that inherit the performance advantages of the PS Series. Brake equipped series and high environmental resistance series are also available.

Features:

1. Low profile
2. High-speed positioning
3. High-accuracy position sensor
4. Inner rotor

CAT. No. E3511

High-Speed Integrated Motor Spindles

B1 Series

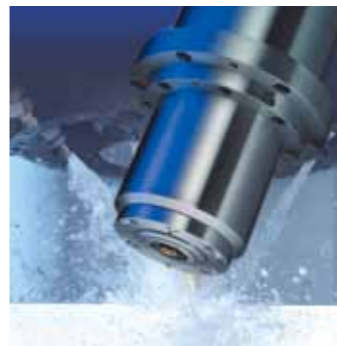

Achieved energy-efficient, quiet operation with grease lubrication; the world's premier, high-performance integrated motor Spindle.

Features:

1. Low noise
2. High rigidity
3. All-in-one design
4. Maintenance-free operation

CAT. No. E2204

Grease Replenishing System

Fine-Lub II



Enhanced eco-friendly performance; grease lubrication ensures energy-efficient, quiet and environmentally sound operation. It is incorporated in the B1 Series.

Features:

1. Provides small quantities of grease
2. Maintenance-free operation
3. Eco-friendly

CAT. No. E1273

Others

A wide lineup of peripheral devices for Ball Screws and NSK Linear Guides

We provide special bearings, Support Units and replenishing grease that maximize the performance potential of our superior precision products. In addition, we manufacture and sell exposure equipment that uses cutting-edge technology, which we have accumulated in our precision products.



Exposure Equipment for Large LCD Color Filter **RZ Series**



Cost-effective exposure equipment that realizes high accuracy with the proximity method.

Features:

1. High productivity
2. Originally developed precision positioning technology
3. High reliability

Precision Bearings for Machine Tools **Robust Series**



The Robust Series of high-accuracy, high-speed bearings represents the epitome of NSK's craft, in materials, evaluation and analysis technologies; reliable support for high-performance machine tools.

Features:

1. Wide variety
2. High accuracy
3. High speed

CAT. No. E1257

For Heavy Loads and Machine Tools **Support Units**



Heavy load support unit developed for machine tools incorporating TAC Series.

Features:

1. Ease of use
2. Short-term delivery
3. Wide variety

CAT. No. E3162

Air Bearings



Ideal rotating body that reaches beyond the conventional concept of a bearing; essential for high-tech industries that require super precision.

Features:

1. High rigidity, low flow consumption
2. Seizure resistant
3. Suitable for air turbines

CAT. No. 1389

Ball Screw Support Bearings **TAC B Series**



High-rigidity, long-life angular contact thrust ball bearings developed specifically for machine tools.

Features:

1. High rigidity
2. Long operating life
3. Universal combination

CAT. No. E1254

Ball Screw Support for Heavy Loads **TAC03 Series TAC-HR, SHR Series**



A series of high-load capacity, angular contact thrust ball bearings that deliver optimal support for Ball Screws under heavy load conditions.

Features:

1. High-load capacity
2. Compact design
3. Universal combination

CAT. No. E1254, E3238

For Light Loads and Small Equipment **Support Units**



Support unit for light loads and small equipment, aligned with standard angular-contact ball bearings; low-dust emission type for clean environments and low-profile type also available.

Features:

1. Ease of use
2. Short-term delivery
3. Low torque

CAT. No. E3162

NSK Clean Grease **LG2 / LGU**



With excellent low dust emission and low torque, LG2 proves its worth in clean room environments; LGU is suitable over a wide temperature range and offers superior durability. Various greases for general use are also available.

Features:

1. Low dust emission
2. Low torque
3. Long life

CAT. No. E3317

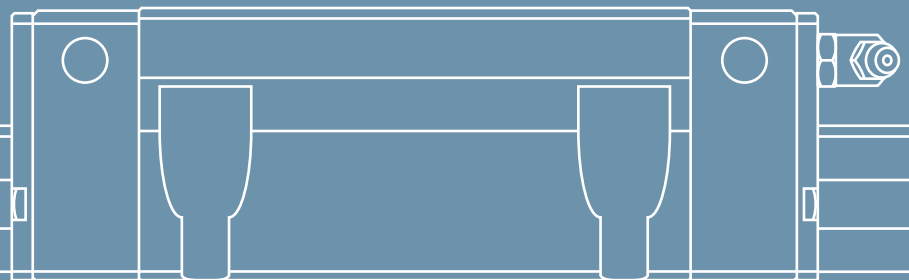
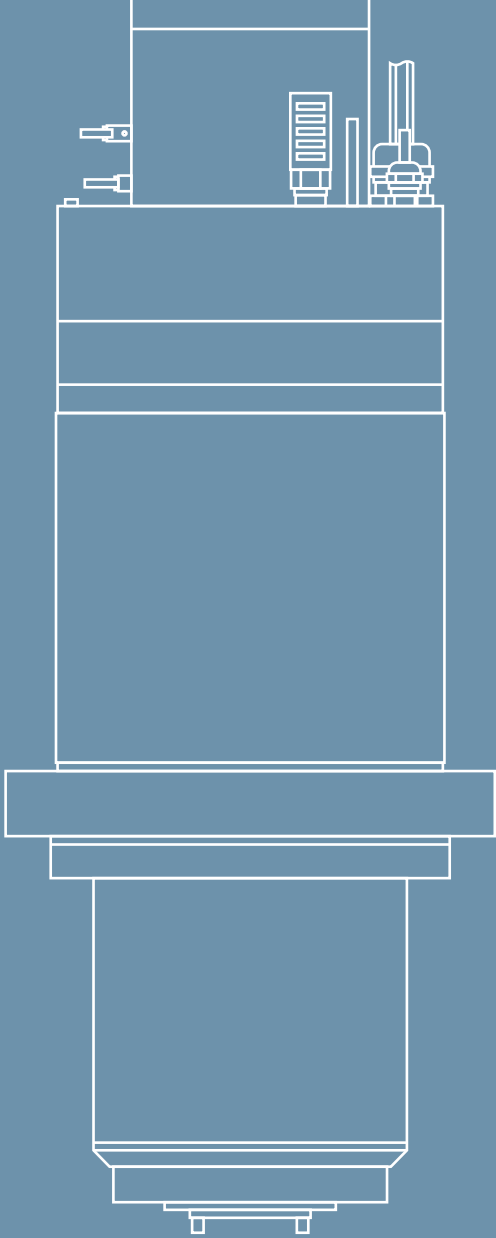

www.nsk.com



NSK used environmentally friendly paper and printing methods for this publication.