

Super Precision Bearings for Machine Tools

Outstanding speed, rigidity, and precision deliver improved machine tool performance while reducing energy loss and placing less burden on the global environment.



NSK's key technologies meet the demand for high performance precision bearings and environmental preservation.

Tribology, the study of friction and wear, is a core NSK technology that not only saves energy and resources by decreasing friction and wear on machines, but also prevents machine malfunction and thereby improves reliability. NSK has established four key technologies around this central expertise as the foundation for developing environmentally sound products. These are: analysis technology toward comprehensively reducing energy loss; evaluation technology for precisely meeting market needs; lubrication technology for reducing energy loss and making higher performance compatible goals and material technology to extend product life.

Analysis Technology

NSK developed its own software, Bearing Analysis In NSK (BRAIN), which enables digital simulations of friction-related movement and performance by applying tribology. The combined use of this simulation data with a finite element method (FEM) leads to the realization of advanced computer-aided engineering (CAE).

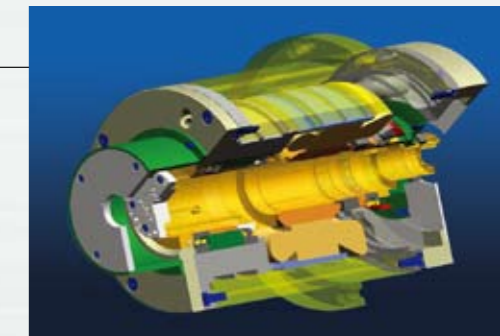

Evaluation Technology

NSK has established an evaluation technology that spans a wide range of applications by employing advanced technologies such as nano-order runout measurement using ultrahigh-precision measuring instruments. Our evaluation technology contributes to the development of cutting-edge products that correspond with increasingly sophisticated market needs.



Lubrication Technology

Through the relentless application of tribology, NSK's key technology, NSK has pursued lubrication technologies that allow machines to deliver maximum performance. NSK's accomplishments in these efforts contribute to saving energy and resources, thereby conserving the global environment.



Material Technology

Research and development across a wide range of material technologies has been conducted to produce ever-higher performing products. Products made of NSK's proprietary materials deliver long life under harsh conditions, are maintenance-free and support various applications throughout many industries.



Eco-friendly lubrication that achieves the same high-speed region as oil-air lubrication

NSK's grease technology supports speeds that are normally only possible with oil-air lubrication systems. These high performance, energy-saving machining center bearings also exhibit outstanding noise reduction.

High-Speed, High Precision Sealed Angular Contact Ball Bearings –ROBUST Wide Series

NSK improves machine tool reliability by providing higher performance and greater durability. This series of bearings further provides excellent support towards a clean working environment and saving energy.

Features

1. Longer life when using grease lubrication
2. Low-heat generation
3. High reliability and shorter assembly process time

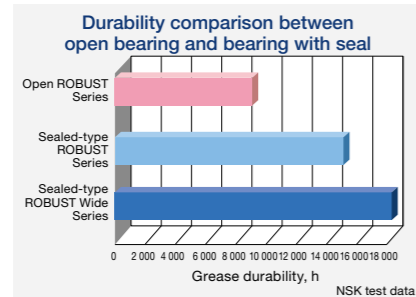

Test Conditions:
Bore diameter of bearing: 65 mm; Ceramic ball specification;
Rotation: 18 000 min⁻¹ ($d_m n = 1\,480\,000$); Lubrication: MTE grease



Grease Replenishing System for High-Speed Grease Lubrication Spindles

New automatic lubrication system converts conventional oil lubrication methods for high-speed spindles.

Features

1. High-speed performance and long life ensured with grease lubrication.
2. Capable of providing more than 10 000 maintenance-free hours.
3. Environmentally sound, low-noise bearing saves energy.

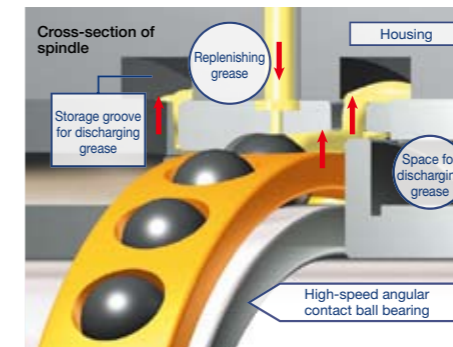

Structure for Feeding Grease to Bearings



High Precision Angular Contact Ball Bearings –Standard Series

NSK's basic series of precision angular contact ball bearings conforms to ISO specifications.

Features

1. Long life bearing steel (Z steel) used as standard material. Z steel offers 1.8 times longer life when compared to standard SUJ2 bearing steel.
2. The 70 and 79 series are available in sealed form and offer 1.5 times greater grease durability.
3. Two types of cages are available for specific bearing types.



High-Speed Integrated Motor Spindle for Machining Centers

Achieved 20 000 min⁻¹ with ISO-40 equivalent taper using NSK's automatic grease replenishing system.

Features

1. Highest speed for NT#40 class high-speed machining center using grease-lubricated bearings
2. 10 000 maintenance-free hours are made possible by the NSK grease replenishing system.
3. Wide range of machining performance from low to high speeds

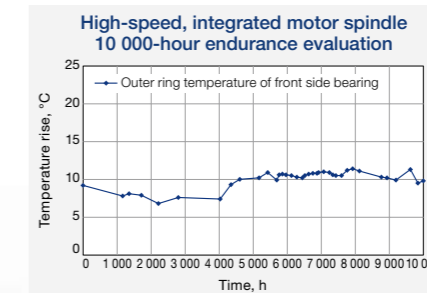

High Performance Double-Row Cylindrical Roller Bearings—Low-Heat Generation NN-Z Series

New material and design for the bearing cage enhance machine tool performance.

Features

1. High-speed performance and low-heat generation
2. Longer life with grease lubrication
3. Low-heat generation series specifically for free-end bearings



High Performance Grease Products (MTS, MTE, and ENS) for Machine Tools

Grease features

- MTS: For high-speed rotation. Contains urea thickener and exhibits excellent heat resistance.
- MTE: For high-speed rotation offers outstanding load capability.
- ENS: Environmentally friendly due to its biodegradability.



Oil-air lubrication reduces energy loss in ultrahigh-speed applications

NSK machining center bearings facilitate high-speed rotation in ultrahigh-speed applications, which require extremely reliable oil-air lubrication, while achieving environmental friendliness and energy conservation.

New Outer Ring Guided PPS Engineered Polymer Cage (TS) for ROBUST Angular Contact Ball Bearings

Cage movement is controlled by the bearing and achieves low torque during high-speed rotation, and new cage lowers energy loss.

Features

Compared with existing phenolic cages:

1. 20% less heat generation with low temperature rise
2. 25% higher speeds
3. 50% decrease in cage runout

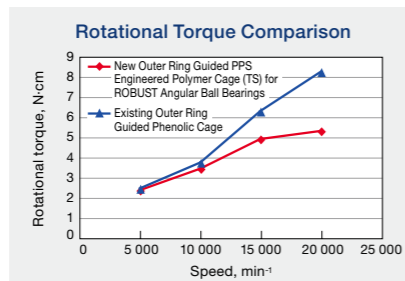

Test conditions:
Bearing: 70BNR10H
Speed: 5 000–20 000 min⁻¹
Constant pressure preload: 1 000 N
Lubrication: Grease



Ultrahigh-Speed, High Precision Angular Contact Ball Bearings –ROBUST Series Spinshot™ II

In the quest to optimize oil supply, NSK has achieved unprecedented low-noise characteristics while reaching higher rotational speeds.

Features

1. Achieves 40 000 min⁻¹ with ISO-40 equivalent taper using oil-air lubrication.
2. Noise levels reduced by 3 dB to 5 dB compared with conventional oil-air lubrication.
3. Achieves 40 000 min⁻¹ with approximately half the air volume of conventional oil-air lubrication.



Ultrahigh-Speed, High Precision Angular Contact Ball Bearings—ROBUST Series

These bearings integrate the pride of NSK material, evaluation, and analysis technologies into a highly functional series that supports high performance machine tools.

Features

1. TS cage facilitates even lower heat generation and higher speed rotation.
2. X-type achieves high-speed performance and long life through the use of SHX material, which delivers outstanding resistance to heat and wear.
3. Extensive lineup available for specific applications

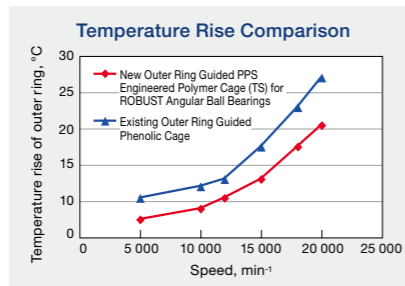

Test conditions:
Bearing: 70BNR10XDDB
Lubrication: DTE Light oil (VG32)
Preload method: Position preload
Cooling: Non-cooling



Spinshot™ II Structure Diagram

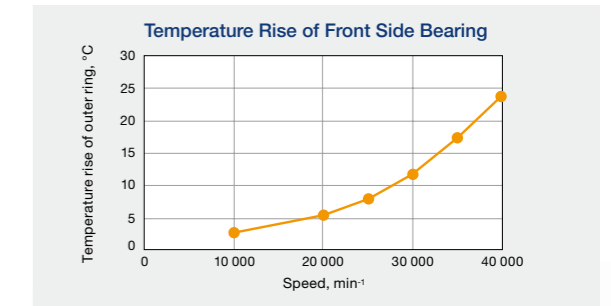
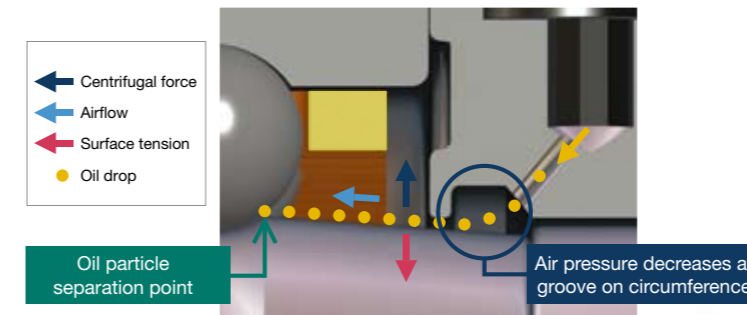

Bearings used: 65BAXTD for front side; 558NXETD for rear side

Small Diameter, Ultrahigh-Speed, High Precision Angular Contact Ball Bearings –ROBUST BGR Series

This highly functional series supports high performance of small spindles with bore diameters of 30 mm or less, delivering high precision and ultrahigh-speed rotation.

Features

1. Ultrahigh-speed bearings are specially designed for small spindles.
2. X-type achieves high-speed performance and long life through the use of SHX material with excellent heat and wear resistance.
3. Standardized for ISO Class 2.



Ultrahigh-Speed Single Row Cylindrical Roller Bearings—ROBUST Series

This series achieves $d_m n$ 2 200 000 using highly heat-resistant PEEK cage and SHX material, which deliver outstanding heat and wear resistance.

Features

1. Optimal design enabling low-heat generation.
2. Seizure-resistant performance improved through use of SHX material.
3. Heat-resistant, highly rigid, PEEK engineered polymer boosts speed.



Addressing environmental conservation while maintaining both outstanding rigidity and high-speed performance

This lineup proves superior for reducing energy loss by restricting heat generation while achieving outstanding rigidity and high speed. Ceramic ball type performance also generates less heat while delivering enhanced rigidity and precise performance.

Roller-Guided PPS Resin Cage (TB) with Engineered Polymer

Use of high-strength engineered polymer L-PPS reduces deformation caused by centrifugal force and facilitates stable rotation in high-speed applications. This is a long-life cage with low temperature rise.

Features

1. Optimal roller-guided cage design with consideration for strength and friction
2. Use of high-strength engineered polymer L-PPS facilitates stable rotation in high-speed applications.
3. Achieves longer life with grease lubrication in comparison with that of metal cages.

FEM Analysis of Deformity

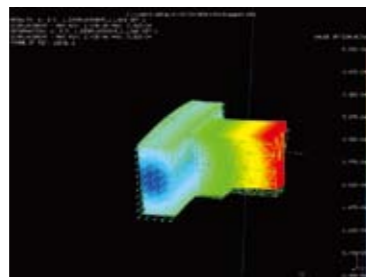

High Rigidity

Highly Functional, Double-Row Cylindrical Roller Bearings –High Rigidity ROBUST TB Series

New material and cage design enhance machine tool performance.

Features

1. Achieves high-speed and low-heat generation.
2. Longer life possible with grease lubrication

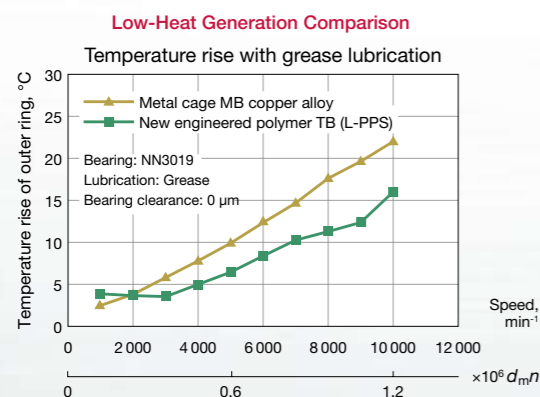

High Precision

Ultrahigh Precision Ceramic Angular Contact Ball Bearings—ROBUST Ultrahigh Precision Specification P2X

This series achieves the world's highest rotational accuracy, exceeding ISO Class 2 for high-precision processing of small lathes.

Features

1. Ultrahigh rotational accuracy
2. NRRO value is guaranteed.
3. Ceramic ball precision is significantly improved.



High Speed

High-Precision Thrust Angular Contact Ball Bearings—ROBUST Series

The ROBUST series features high-speed performance and low heat generation without compromising rigidity.

Features

- BTR with contact angle 40°: High thrust rigidity and low-heat generation are compatible.
- BAR with contact angle 30°: Greater emphasis on high speed than BTR



High Rigidity

High-Precision Thrust Angular Contact Ball Bearings—TAC-F Series

A highly precise thrust angular contact ball bearing with priority placed on rigidity at a contact angle of 50°.



Limiting Speeds of ROBUST Series and TAC-F Series with Grease Lubrication (when lightly preloaded)

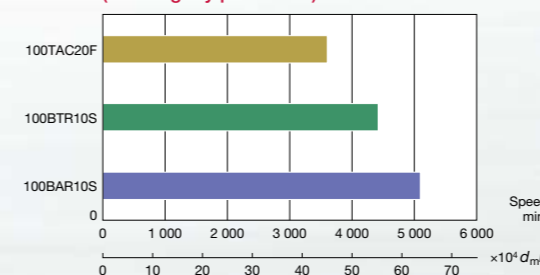

Axial Load and Axial Displacement of ROBUST Series and TAC-F Series

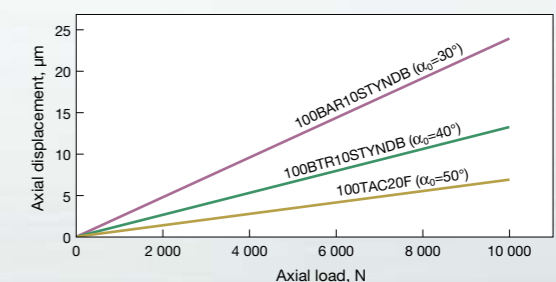

Ball Screw Support Bearings (Grease Lubrication)

Grease lubrication ensures durability and reduces energy loss

Two types of bearings with reliable seals; light contact seals with superior dust proofing qualities or non-contact seals that achieve low torque. Eco-friendliness is now achieved in the area of precision processing in which oil lubrication is conventionally used to prevent fretting, by taking advantage of optimum grease or ceramic balls.

Sealed Angular Contact Thrust Bearings Series for Ball Screw Support

A sealed type series has been added to broaden this product line with outstanding high performance and high rigidity for ball screw support.

Features

1. Adopts long-life, highly reliable EP steel for triple the operating life over standard bearing steel.
2. Grease lubrication extends durability.
3. High rigidity achieved with an angular contact of 60°.
4. Light-contact seal achieves high dust resistance and low temperature rise.



Light-contact seal with dust-resistant characteristics boosts reliability

Adopts NSK's proprietary light-contact seal focusing on high speed. Limited temperature rise ensures outstanding reliability.

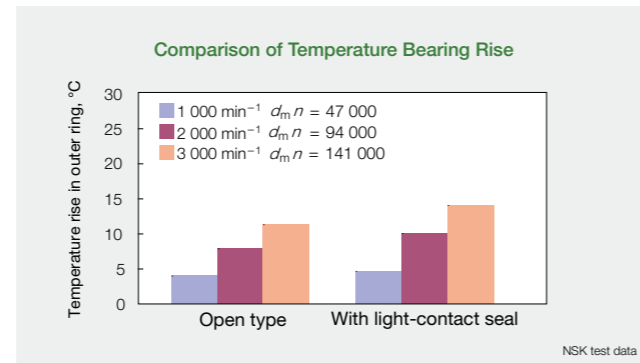
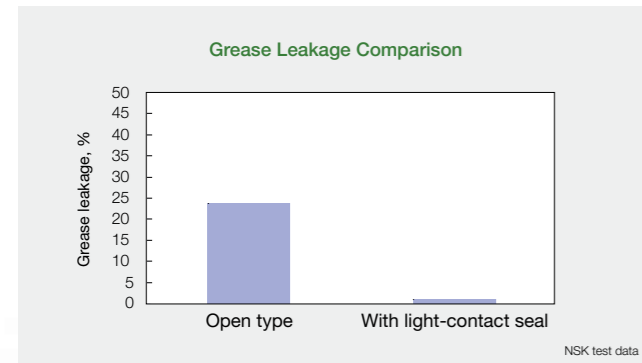

Test conditions:
Bearing: $\phi 30 \times \phi 62 \times 15$ mm; Combination: DFD
Preload: 4 500 N; temperature: room temperature; Speed: 3 000 m⁻¹

Test conditions:
Bearing: $\phi 30 \times \phi 62 \times 15$ mm; Combination: DFD
Preload: 4 500 N; Temperature: room temperature

Extensive Lineup

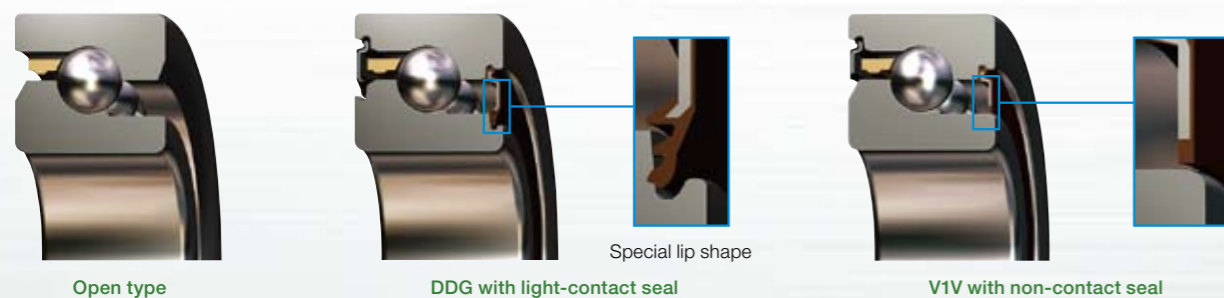

New Grease Specialized for Ball Screw Support Bearings—EA9

With low temperature rise and high fretting resistance, this grease is suitable for higher precision processing.

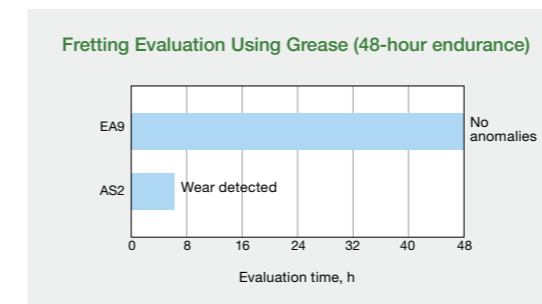

Evaluation conditions:
Bearing: 35TAC72BDFDC10PN7A;
Oscillating angle: 2.5°; One cycle: 0.4 seconds

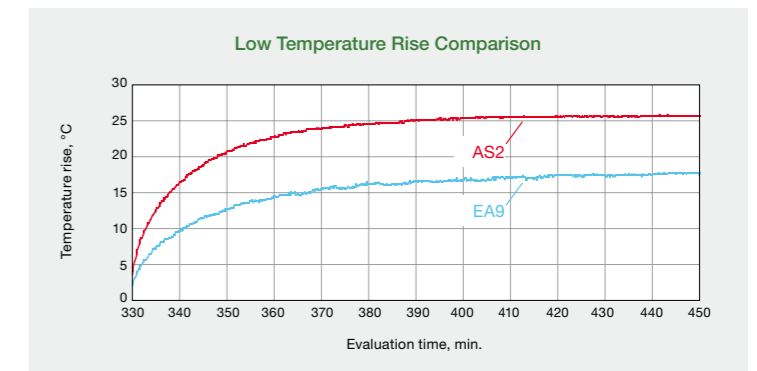

Evaluation conditions:
Bearing: 20TAC47BDFDC10PN7A; Grease quantity: 2 g (50% of space capacity);
Maximum operating speed: 2 085 min⁻¹

Ball Screw Support Bearings Ceramic Ball Specifications

Achieves low temperature rise using ceramic balls for ball screw support bearings. Also features excellent anti-fretting characteristics with a durability of more than 50 times that of steel balls.

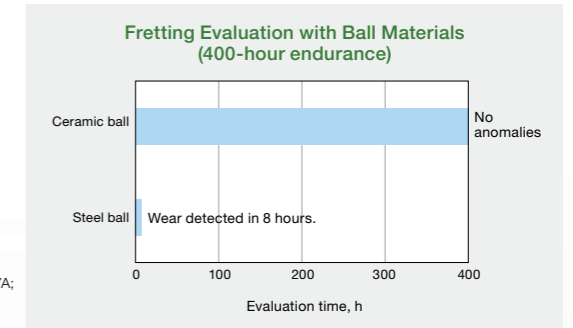

Evaluation conditions:
Bearing: 35TAC72BDFDC10PN7A;
Grease: Alvania (AS2);
Oscillating angle: 2.5°;
One cycle: 0.4 seconds

Ball Screw Support Bearings Ball Screw Support Unit

Improved ease of handling by incorporating ball screw support bearings into unit.

Features

1. Designed with dustproofing characteristics to facilitate design of ball screw support parts.
2. Easier to handle since the bearings are already mounted in the housing.



Specially designed angular contact ball bearings aid in reducing energy loss for swiveling (rotary/tilt) spindle heads and rotary/tilt tables used in machine tools

New bearing available for high-precision machine tools using multi-axis processing. Angular contact ball bearings achieve high rigidity and low torque for swiveling spindle heads used in machine tools in which roller bearings were previously used.

Low profile, Highly Accurate, Angular Contact Ball Bearings—ROBUST Slim Series

Specially designed angular contact ball bearings for swiveling spindle heads and rotary/tilt tables used in machine tools. These bearings allow for a high rotational accuracy found only in bearings with high moment stiffness that is on a par with crossed-roller bearings.

Features

1. Lower torque rotation is achieved with ball bearings.
2. Rotational runout of 0.5 μm or less achieved.
3. High moment stiffness is on a par with crossed-roller bearings.
4. Thin cross-section profile is 35% thinner than that of a standard angular contact ball bearing.

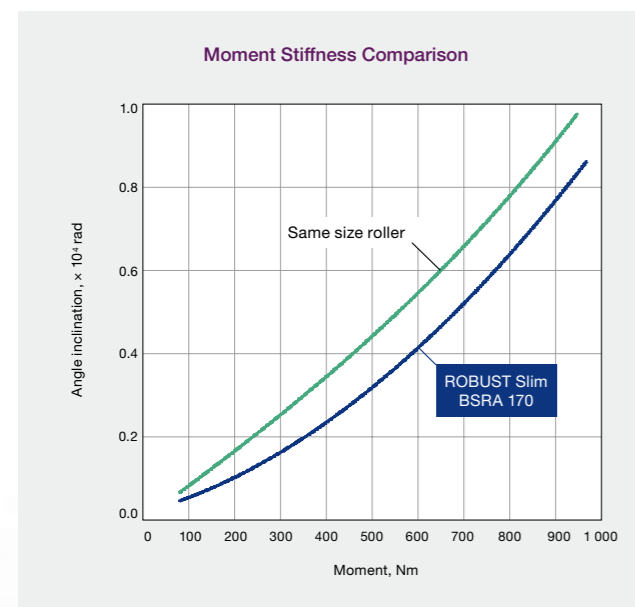
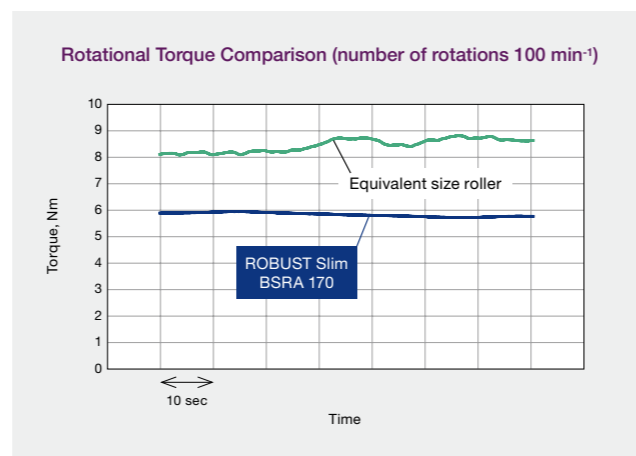

Eco-friendly Bearings with Seals

The ROBUST Slim series is packed with grease after cleaning and removing oil. Production lead time is significantly shortened since the bearings can be mounted into machines immediately after opening their packaging. In addition, use of grease lubrication eliminates atomizing of oil that is generated in oil lubrication for an overall cleaner work environment.



Rotational Runout Measurement

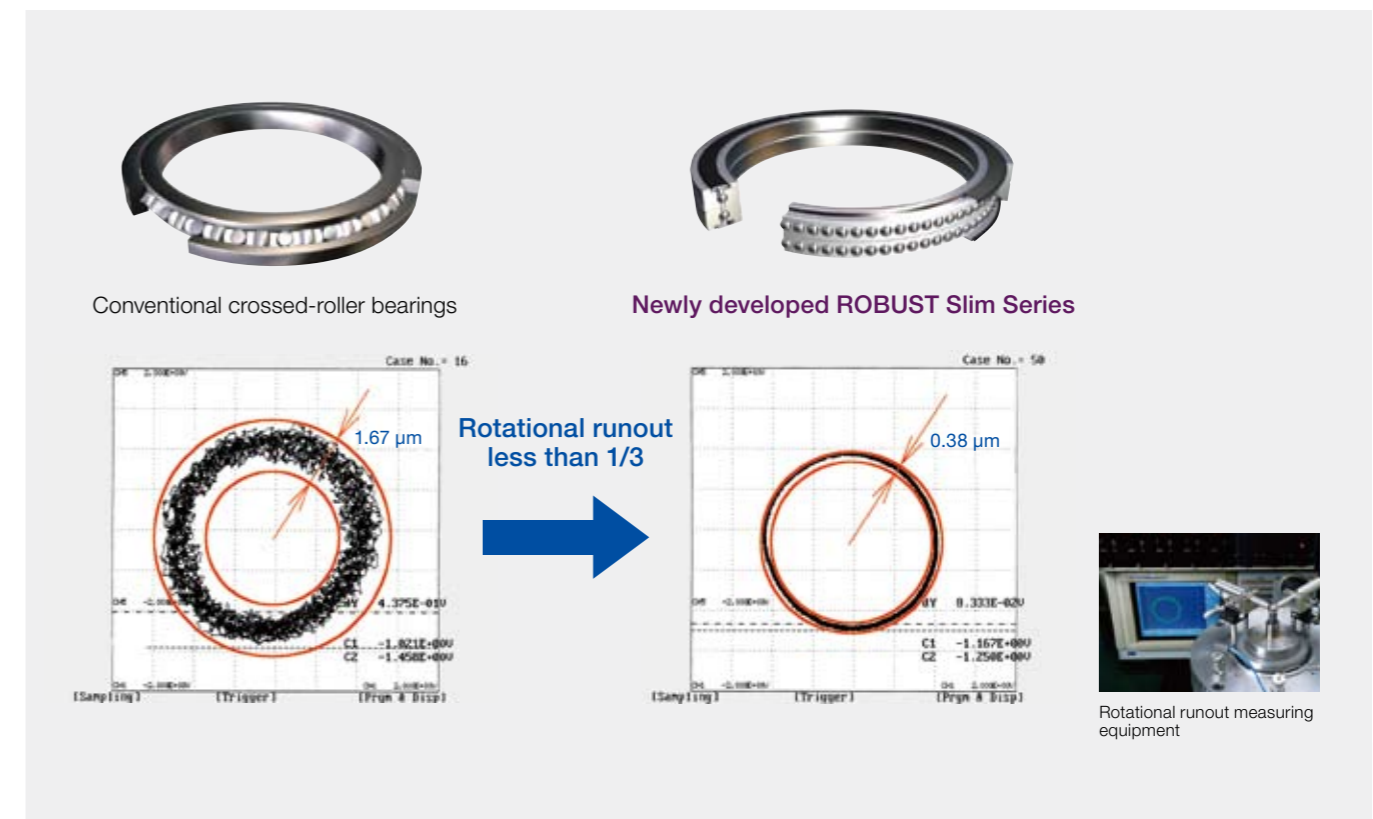

BRSA Series (bore diameter: 130, 170, 220, 340 and 400 mm)

Bearing numbers	Boundary dimensions (mm)				Basic load ratings (kN)	
	d	D	B	r (min.)	C_r (Basic dynamic load rating)	C_{or} (Basic static load rating)
BRSA130S DB	130	165	22	0.6	21.6	53.0
BRSA170S DB	170	215	27	0.6	37.0	96.5
BRSA220S DB	220	270	31	1.0	48.5	141.0
BRSA340S DB	340	420	50	1.1	105.0	325.0
BRSA400S DB	400	500	62	1.1	149.0	480.0

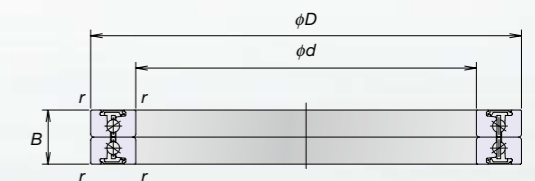

Angular Contact Ball Bearings

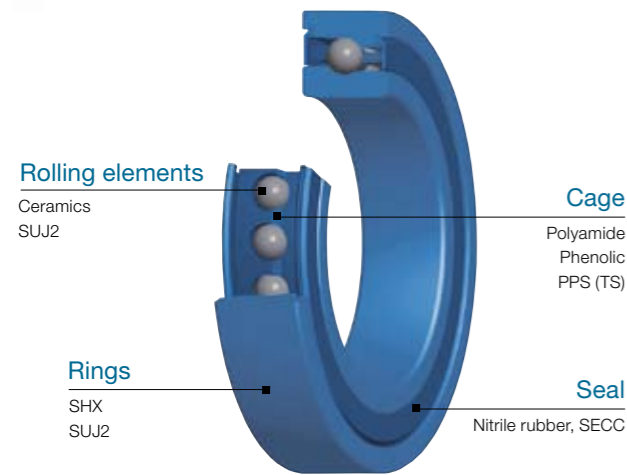

Series	Type	Rings	Rolling elements	Cage
Standard	SUJ2	SUJ2	SUJ2	Polyamide 46 (TYN) Phenolic (TR)
	Ceramic ball type	SUJ2	Ceramics	
ROBUST	S	SUJ2	SUJ2	Polyamide 46 (TYN) Phenolic (TR) PPS (TS)
	H	SUJ2	Ceramics	
	X	SHX	Ceramics	

Angular Contact Thrust Bearings for Ball Screw Support

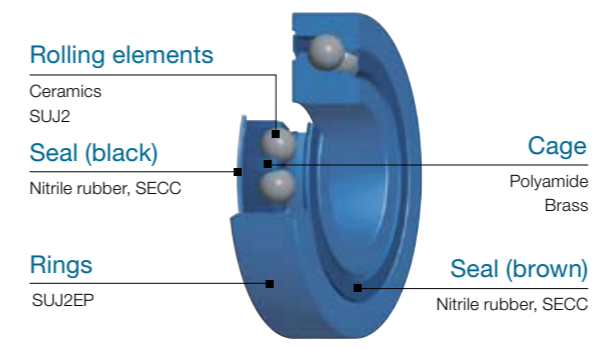

Rings	Rolling elements	Cage
SUJ2EP	Ceramics SUJ2	Polyamide 66

Cylindrical Roller Bearings

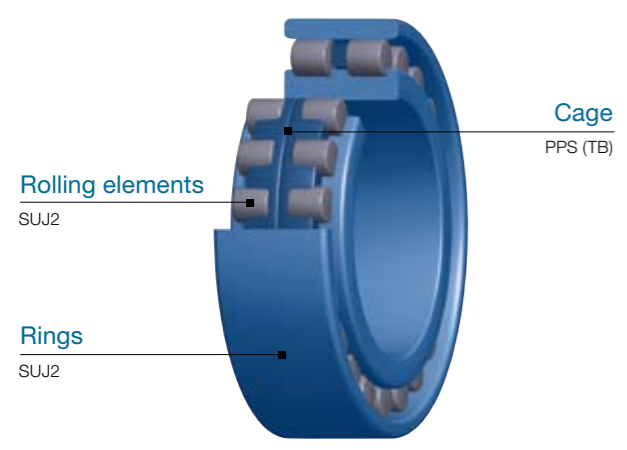

■ NN30

Type	Rings	Rolling elements	Cage
Standard	SUJ2	SUJ2	PPS (TB)

Low-Profile Angular Contact Ball Bearings for Rotary/Tilt Applications

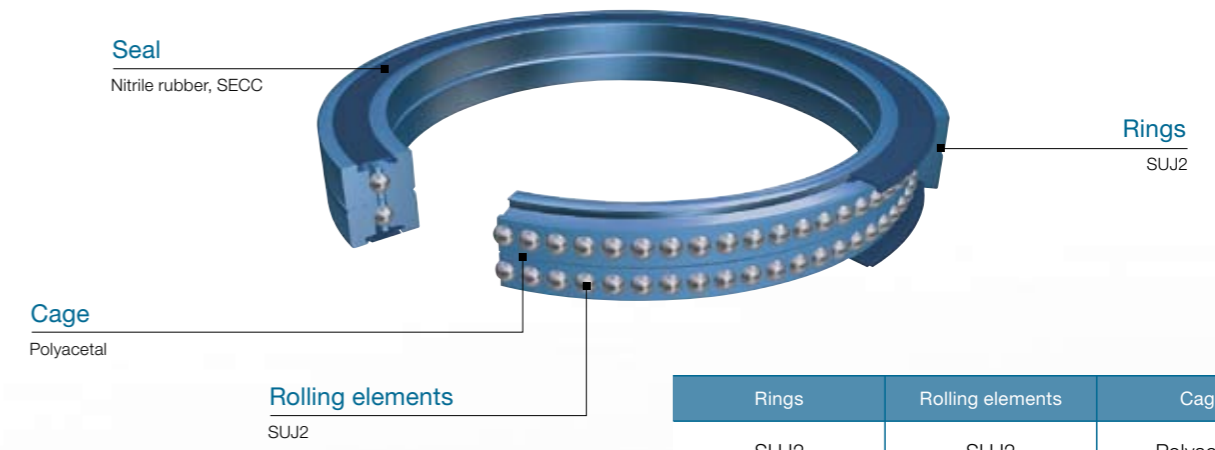

Rings	Rolling elements	Cage
SUJ2	SUJ2	Polyacetal

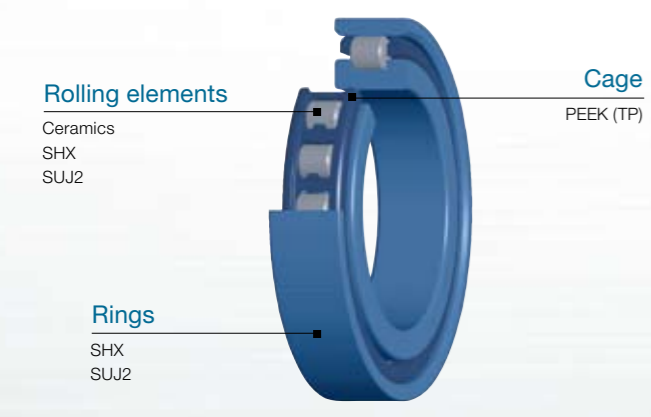

■ N10

Type	Rings	Rolling elements	Cage
RS	SUJ2	SUJ2	PEEK (TP)
RX	SHX	SHX	
RXH	SHX	Ceramics	

Super Precision Bearings Catalog

NSK has compiled all the information it has accumulated about precision bearings over the years into a single catalog. The catalog contains a wealth of technical data regarding precision bearings as well as the information required and key points for selecting bearings, precautions for handling bearings during mounting, and so on. For details, please contact NSK or visit www.nsk.com to request this comprehensive Super Precision Bearings catalog.

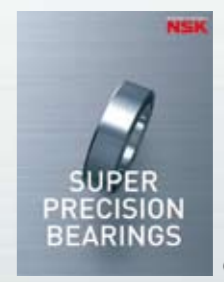

CAT. No. E1254

Worldwide Sales Offices

NSK LTD.-HEADQUARTERS, TOKYO, JAPAN www.nsk.com
 INDUSTRIAL MACHINERY BUSINESS DIVISION-HEADQUARTERS tel: 03-3779-7227
 GLOBAL AFTERMARKET DEPARTMENT tel: 03-3779-7253
 PRECISION MACHINERY DEPARTMENT tel: 03-3779-7163
 MECHATRONICS BUSINESS DEPARTMENT tel: 0466-21-3027
 AUTOMOTIVE BUSINESS DIVISION-HEADQUARTERS tel: 03-3779-7189

Africa

South Africa:
NSK SOUTH AFRICA (PTY) LTD.
 Johannesburg tel: 011-458-3600

Asia and Oceania

Australia:
NSK AUSTRALIA PTY. LTD. www.au.nsk.com
 Melbourne tel: 03-9764-8302

China:

NSK HONG KONG LTD.
 Hong Kong tel: 2739-9933
 Shenzhen tel: 0755-25904886

KUNSHAN NSK CO., LTD.
 Kunshan tel: 0512-5771-5654

CHANGSHU NSK NEEDLE BEARING CO., LTD.
 Jiangsu tel: 0512-5230-1111

NSK STEERING SYSTEMS DONGGUAN CO., LTD.
 Dongguan tel: 0769-2262-0960

NSK (CHINA) RESEARCH & DEVELOPMENT CO., LTD.
 Jiangsu tel: 0512-5796-3000

NSK (SHANGHAI) TRADING CO., LTD.
 Jiangsu tel: 0512-5796-3000

NSK (CHINA) INVESTMENT CO., LTD.
 Jiangsu tel: 0512-5796-3000

Beijing tel: 010-6590-8161

Guangzhou tel: 020-3786-4833

Chengdu tel: 028-8661-4200

NSK CHINA SALES CO., LTD.

Shanghai tel: 021-6235-0198

Changchun tel: 0431-8898-8682

Tianjin tel: 022-8319-5030

Nanjing tel: 025-8472-6671

Chongqing tel: 023-6806-5310

India:

RANE NSK STEERING SYSTEMS LTD.
 Chennai tel: 044-474-06017

NSK INDIA SALES CO. PVT. LTD.
 Chennai tel: 044-2433-1161

Gurgaon tel: 0124-4104-530

Kolkata tel: 033-4001-2062

Mumbai tel: 022-2838-7787

NSK-ABC BEARINGS LTD.
 Chennai tel: 044-2714-3000

Indonesia:

PT. NSK INDONESIA
 Jakarta tel: 021-252-3458

Korea:

NSK KOREA CO., LTD. www.kr.nsk.com
 Seoul tel: 02-3287-0300
 Changwon tel: 055-287-6001

Malaysia:

NSK BEARINGS (MALAYSIA) SDN.BHD. www.my.nsk.com
 Shah Alam tel: 03-7803-8859

New Zealand:

NSK NEW ZEALAND LTD. www.nsk-rhp.co.nz
 Auckland tel: 09-276-4992

Philippines:

NSK REPRESENTATIVE OFFICE
 Manila tel: 02-893-9543

Singapore:

NSK INTERNATIONAL (SINGAPORE) PTE LTD.
 Singapore tel: 6496-8000
NSK SINGAPORE (PRIVATE) LTD. www.nsk-singapore.com.sg
 Singapore tel: 6496-8000

Taiwan:

TAIWAN NSK PRECISION CO., LTD.
 Taipei tel: 02-2509-3305

TAIWAN NSK TECHNOLOGY CO., LTD.
 Taipei tel: 02-2509-3305

Thailand:

NSK BEARINGS (THAILAND) CO., LTD.
 Bangkok tel: 02320-2555

SIAM NSK STEERING SYSTEMS CO., LTD.
 Chachoengsao tel: 038-522-343

NSK ASIA PACIFIC TECHNOLOGY CENTER (THAILAND) CO., LTD.
 Chonburi tel: 038-454-631

Vietnam:

NSK VIETNAM CO., LTD.
 Hanoi tel: 04-3955-0159

NSK REPRESENTATIVE OFFICE
 Ho Chi Minh City tel: 08-3822-7907

Europe

NSK EUROPE LTD. (EUROPEAN HEADQUARTERS) www.eu.nsk.com
 Maidenhead tel: 01628-509-800

France:

NSK FRANCE S.A.S.
 Paris tel: 01-30-57-39-39

Germany:

NSK DEUTSCHLAND GMBH
 Düsseldorf tel: 02102-4810

NSK PRECISION EUROPE GMBH
 Düsseldorf tel: 02102-4810

Italy:

NSK ITALIA S.P.A.
 Milano tel: 0299-5191

Poland:

NSK EUROPE LTD. WARSAW LIAISON OFFICE
 Warsaw tel: 022-645-1525

NSK EUROPEAN TECHNOLOGY CENTER, POLAND OFFICE
 Kielce tel: 041-367-0940

NSK STEERING SYSTEMS EUROPE (POLSKA) SP.ZO.O.
 Walbrzych tel: 074-664-4101

NSK NEEDLE BEARING POLAND SP.ZO.O.
 Kielce tel: 041-345-2469

NSK POLSKA SP.ZO.O.
 Kielce tel: 041-347-5110

Spain:

NSK SPAIN S.A.
 Barcelona tel: 093-433-5775

Turkey:

NSK RULMANLARI ORTA DOGU TIC. LTD. STI.
 Istanbul tel: 0216-355-0398

United Kingdom:

NSK EUROPEAN TECHNOLOGY CENTER
 Newark tel: 01636-605-123

NSK UK Ltd.
 Newark tel: 01636-605-123

NSK PRECISION UK LTD.
 Newark tel: 01636-605-123

NSK STEERING SYSTEMS EUROPE LTD.
 Maidenhead tel: 01628-509-800

North and South America

NSK AMERICAS, INC. (AMERICAN HEADQUARTERS)
 Ann Arbor tel: 734-913-7500

Argentina:

NSK ARGENTINA SRL
 Buenos Aires tel: 11-4704-5100

Brazil:

NSK BRASIL LTDA. www.br.nsk.com
 São Paulo tel: 011-3269-4786

Canada:

NSK CANADA INC. www.ca.nsk.com
 Toronto tel: 905-890-0740

Mexico:

NSK RODAMIENTOS MEXICANA, S.A. DE C.V. www.mx.nsk.com
 Mexico City tel: 55-3682-2900

United States of America:

NSK CORPORATION www.us.nsk.com
 Ann Arbor tel: 734-913-7500

NSK AMERICAN TECHNOLOGY CENTER
 Ann Arbor tel: 734-913-7500

NSK PRECISION AMERICA, INC. www.npa.nsk.com
 Franklin tel: 317-738-5000

NSK STEERING SYSTEMS AMERICA, INC. www.nssa.nsk.com
 Bennington tel: 802-442-5448

NSK LATIN AMERICA, INC. www.la.nsk.com
 Miami tel: 305-477-0605

<As of January 2010>

For the latest information, please refer to the NSK website.

NSK Ltd. has a basic policy not to export any products or technology designated as controlled items by export-related laws. When exporting the products in this brochure, the laws of the exporting country must be observed. Specifications are subject to change without notice and without any obligation on the part of the manufacturer. Every care has been taken to ensure the accuracy of the data contained in this brochure, but no liability can be accepted for any loss or damage suffered through errors or omissions. We will gratefully acknowledge any additions or corrections.

For more information about NSK products, please contact: _____

